

EL series

Contents of EL series repair parts kit

Parts name	qty
Filter element	1
Diaphragm	2
Valve box	2
Bolt	2
Nut	2
Washer	2
Magnet support jig	4

Fig. 1

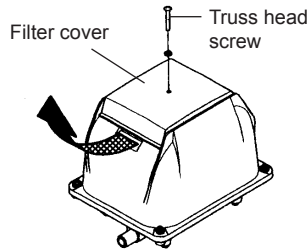

Fig. 2

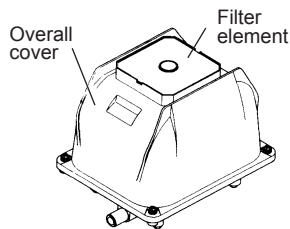

Fig.3

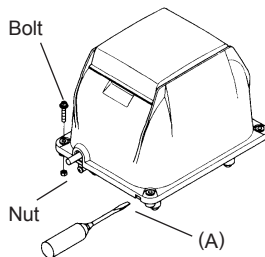

Fig. 4

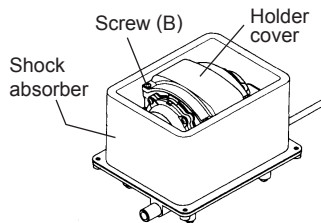

Fig. 5

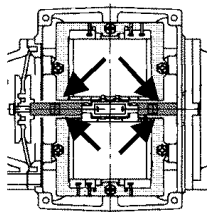
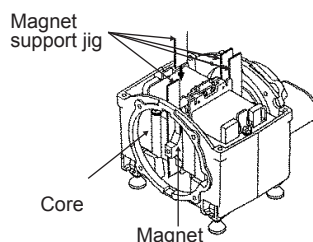

Fig. 6



⚠ WARNING

- Always disconnect the power before servicing. Failure to do so could result in electrical shock, personal injury or death.

⚠ CAUTION

- Clean the filter element quarterly. A clogged filter element can cause overheating or pump failure.

- 2 kits are required for EL-120W, 150, 200.

1 Filter element cleaning

- Undo the truss head screw and remove the filter cover (Ref. : Fig. 1).
- Remove the filter element and shake out the dust by hand (Ref. : Fig. 2). If it is heavily clogged, wash it with a neutral detergent. Rinse with water and dry it in the shade.
- Reassemble the filter element back in place and press in the filter cover.
- Fix the filter cover by the truss head screw.

2 Replacement of filter element, valve box, diaphragm

- Replace the filter element following the procedure in 1 Filter element cleaning.
- Undo the four corner bolts and remove the overall cover. In case the overall cover is hard to remove, insert a slotted screwdriver in (A) (Ref. : Fig. 3).
- Remove the shock absorber. Undo the screws (B) and remove the holder cover (Ref. : Fig. 4).
- Insert the magnet support jig in four corners between the magnet and the core (Ref. : Fig. 5, 6).
- Undo the screw (C) and remove the valve box of one side, pinching the hose clamp (Ref. : Fig. 7).
- Undo (D) and remove the diaphragm (Ref. : Fig. 8).

Note :

(D) of EL-60, EL-80-15, EL-120W : Nut

(D) of EL-80-17, EL-100, EL-150, EL-200 : Bolt

- Set the new diaphragm to the magnet and fix them by (D) (Ref. : Fig. 8).

Note :

Use the new nut or bolt (D) in this repair kit.

Note the locating notch for reassembly (Ref. : Fig. 9).

- Set the new valve box and fasten it with the four corner screws (C) (Ref. : Fig. 7).
- Replace the valve box, diaphragm holder and diaphragm of the other side in the same way.
- Pull out the magnet support jig (Ref. : Fig. 5, 6).
- Make sure that clearance between the magnet and the solenoid of both sides is even.

Fig. 7

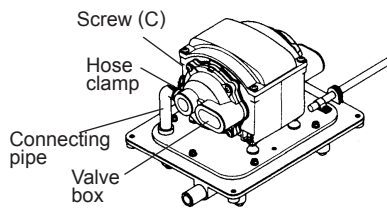

- Connect the exhaust port of the valve box with the connecting pipe and tighten it with the hose clamp securely (Ref. : Fig. 7).
- Reset the auto-stopper, if necessary (Ref. : 3 Reset of auto-stopper).
- Connect power and confirm the operation.
- Fasten the holder cover with the four corner screws (B) and put the shock absorber back into place (Ref. : Fig. 4).
- Put the overall cover, inserting the power cord rubber bushing into the location notch of the overall cover (Ref. : Fig. 10).
- Fasten the overall cover securely by the nuts and bolts.

Fig. 8

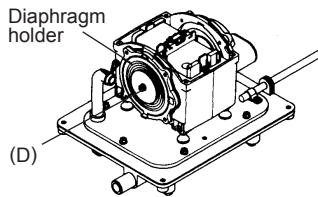

⚠ WARNING

- If the magnet contacts the solenoids during operation, it will cause damage on parts, abnormal heat, and short circuiting.

⚠ DANGER

- Do not touch live parts. Touching live parts will result in electric shock.

Fig. 9

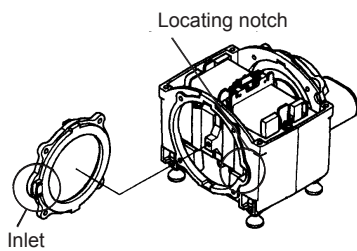

⚠ CAUTION

- Improper setting of the rubber bushing can result in electric shock, airleakage.

3 Reset of auto stopper

⚠ DANGER

- Disconnect the power before servicing. Do not touch the terminal of the switch. If hazard is ignored, electric shock is possible. If not disconnected, the magnet starts moving upon reset of auto stopper. Personal injury is possible.

If the diaphragm is broken, the magnet reciprocates with abnormal amplitude and the projection hits the slider. The contact is interrupted and power is off (Ref. : Fig. 11).

Fig. 10

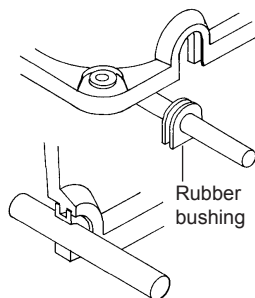

- Insert a slotted screwdriver and push the slider.
- Set the slider at the position L1=L2 (Ref. : Fig. 12).

Fig. 11

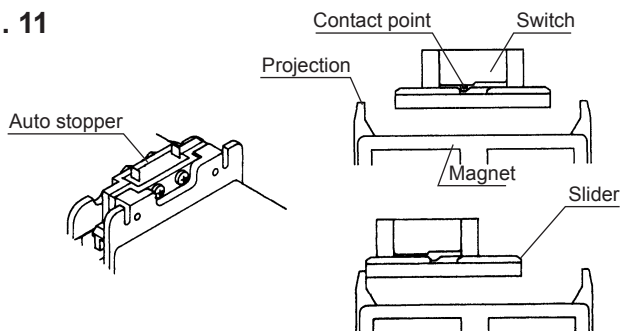

Fig. 12

